

**Third Saturday Seminar 2011-2012**

**Humanity at a Crossroads**

**Session 03**

**19 November 2011**

**War, Taxes and Debt**

**Colin J. N. Chauret, Col., USAF (Ret.)**

**Current Events Segment**

**ALL Program, Lone Star College – Montgomery  
Conroe, Texas**

# Change

**There is only one corner of the universe you can be certain of improving, and that's yourself.**

**Aldous Huxley**

# *Return of the Elders, Unleashing Your Wisdom*

## **Our Middle Aged Brains**

David Niesel and Norbert Herzog

**Ah... if only I could stay young... instead of faking it.**

**No kidding! It's actually true that our brains change with age. There was a report that said forty percent of your brain cells are lost with age but that's actually not true....**

**Something the middle aged brain is better at doing is recognizing the central idea or big picture. So if the brain is in good shape, it can build pathways that allow it to recognize patterns and their significance and find a solution faster than a young person.**

# THRIVE: How to Flourish in an Insane World

By [Dr. Arnie Kozak](#) | Last updated Jul 10, 2011, 11:02 am

Let's face it, the world is a mess. Political unrest, natural disasters, overpopulation, financial turmoil, depletion of natural resources, and war are everyday concerns. And thanks to the Internet and television these concerns are available 24/7 and come right to your living room.

Life has always been stressful. It's easy to idealize a bygone era as a golden age when things were different. There has always been war, unrest, and uncertainty. Yet as few as 50 years ago, it was not in our faces. The availability of information makes life more stressful.

We need tools to help us to cope with everything that is going around us – personally, in the family, community, country, and the world.

## **Program for TSS Meeting 17 September 2011**

- **9:30 am** Introduction & Current Events (45 Minutes +/-) – *Curt Gibby*
- **10:15 am** - 10 Minute Break
- **10:25 am** – War, Taxes and Debt
- **11:55 am** Closing Remarks
- **12:00 noon** – Adjourn - Next Session – **18 February 2012**

# **SAVE THE DATE**

**ALL Spring 2012 Open House  
and Registration:**

**Saturday, January 21**

**11 a.m.-1 p.m.**

**LSC-Montgomery Building A - The  
Commons**

**Donna Smith Burns at (936) 273-7446**

**Email [Donna.SmithBurns@Lonestar.edu](mailto:Donna.SmithBurns@Lonestar.edu)**

# **Third Saturday Seminars**

To refer to an ancient Chinese saying, our world is in interesting times and individual citizens are assaulted with a blinding array of propaganda from every conceivable source. The Third Saturday Seminar is about demystification of what is going on around is. Time will also be spent on current events. 3 Sessions. No fee.

Lone Star College-Montgomery BI02

**16019S 11/19, 2/18/12, 3/24/12, 4/15/12**

**160209:30 a.m. – Noon Gibby**

<http://wwwapps.lonestar.edu/flipbook/ALL/montgomeryfall11/montgomery.html>

**March is the 17<sup>th</sup>** and the **college is closed for Spring Break**, I thought ALL might want to consider a special lecture about Water and the Environment

On 11/16/2011 4:16 PM, Smith Burns, Donna wrote:

FYI

In March 2012 ALL will be part of the LSCM **Spring Fling and the Texas Forest Expo**.

The emphasis for this event on March 24 is: Water, Drought, Forest, Fire and Health Natural Living

The event will be on LSC M campus and the committee expects 2500-3500 students, parents, seniors and community members.

Since the **Third Saturday would be March is the 17<sup>th</sup>** and the **college is closed for Spring Break**, I thought ALL might want to consider a special lecture about Water and the Environment. In the course of the conversation John Warner mentioned a Meteorologist who he hear talk about climate change specific to our region.

I am proposing we consider him as a speaker. I can contact him and then make the introduction to Curt if we want to make it the Third Saturday topic. **(See next Slide)**

I also told my committee I would work on getting a speaker from the San Jacinto Water Authority to discuss Lake Conroe issues.

ALL can have a booth at this event to promote classes and the Nature Series. I will also have a booth for Youth Camp which I will be running 12 Summer.



# March 24th

**On 11/6/2011 6:09 AM, Paul Watson wrote: Curt –**

**While I have understood and tend to be in general agreement with most of your positions, I was surprised when you said that you support a single payer medical system. ... I would welcome the opportunity to discuss this issue at the Third Saturday Seminar and present history, options and considerations of current and future medical care.**

**I am a retired pathologist. I have worked in private practice and the Veterans Administration, as well as having experiences as a patient within the VA as well as in the private world. I have had experience as a part owner of a hospital. As a pathologist I had interface with the administrative considerations of medical care as well. I began practice before Medicare became firmly established. I have had the opportunity to observe various types of practices. I believe that I have a background to understand the advantages and disadvantages of various medical care systems.**

**Paul Watson**

# Current Events

17 September 2011

**Don't***be***Panic***ked!*

Words ...

**“Oh wow. Oh wow. Oh wow.”**

# ... Steve Job's Last

... His breath indicated an arduous journey, some steep path, altitude. He seemed to be climbing.

But with that will, that work ethic, that strength, there was also sweet Steve's capacity for wonderment, the artist's belief in the ideal, the still more beautiful later.

Steve's final words, hours earlier, were monosyllables, repeated three times.

Before embarking, he'd looked at his sister Patty, then for a long time at his children, then at his life's partner, Laurene, and then over their shoulders past them.

Steve's final words were: OH WOW. OH WOW. OH WOW.

# A Sister's Eulogy for Steve Jobs

*Mona Simpson is a novelist and a professor of English at the University of California, Los Angeles. Since 1988, she has held the Sadie Samuelson Levy Chair in Languages and Literature at Bard College. She delivered this eulogy for her brother, Steve Jobs, on Oct. 16, 2011, at his memorial service at the Memorial Church of Stanford University.*

[http://www.nytimes.com/2011/10/30/opinion/mona-simpsons-eulogy-for-steve-jobs.html?\\_r=2&pagewanted=3](http://www.nytimes.com/2011/10/30/opinion/mona-simpsons-eulogy-for-steve-jobs.html?_r=2&pagewanted=3)

*Although nature is logical, human nature is not. Jobs certainly had his demons as do we all. Sometimes it made him brilliant and other times mean-spirited and bullying. And when it came to cancer, his ability to adjust his reality to suit himself, shortened his life, although he seemed to have no regrets.*

*There's much to be learned when you can study an icon, complete with warts.*

## **Sarkozy tells Obama Netanyahu is a "liar"**

*By Yann Le Guernigou / Reuters – Tue, Nov 8, 2011*

PARIS (Reuters) - French President Nicolas Sarkozy branded Israeli Prime Minister Benjamin Netanyahu "a liar" in a private conversation with U.S. President Barack Obama that was accidentally broadcast to journalists during last week's G20 summit in Cannes.

"I cannot bear Netanyahu, he's a liar," Sarkozy told Obama, unaware that the microphones in their meeting room had been switched on, enabling reporters in a separate location to listen in to a simultaneous translation.

"You're fed up with him, but I have to deal with him even more often than you," Obama replied, according to the French interpreter.

## China uneasy over US troop deal in Australia

Beijing fears a policy of encirclement as Barack Obama announces plans to station 250 troops in northern Australia from next year

**Alison Rourke** in Sydney and **Jonathan Watts** in Beijing  
[guardian.co.uk](http://guardian.co.uk), Wednesday 16 November 2011 13.53 EST  
[Article history](#)



Barack Obama and Julia Gillard announce plans to station US troops in northern Australia from next year. Photograph: Larry Downing/Reuters

Strains between [China](#) and the [United States](#) look set to overshadow a key Asian summit later this week after [Barack Obama](#) unveiled plans to station troops in [Australia](#) and step up Washington's commitment to the entire Asia-Pacific region.

<http://www.guardian.co.uk/world/2011/nov/16/china-us-troops-australia>

### More on this story



[Barack Obama tells Asia US 'here to stay' as a Pacific power](#)  
US President Barack Obama tells the Australian parliament the Asia-Pacific region is key to the future

[Obama Australia visit begins](#)



# China's First Aircraft Carrier

## Shi Lang ex-Varyag



19 November 2011

War, Taxes and Debt

17

# South China Sea

<http://news.bbc.co.uk/2/hi/7941425.stm>



# Russian military chief: War risks have grown

MOSCOW (AP) — Russia's chief military officer says the nation is facing an increased threat of being drawn into conflicts at its borders that may grow into an all-out nuclear war.

Gen. Nikolai Makarov, chief of the General Staff, pointed at NATO's expansion eastward and said Thursday that the risks for Russia to be pulled into local conflicts have "risen sharply." He added, according to Russian news agencies wires, that "under certain conditions local and regional conflicts may develop into a full-scale war involving nuclear weapons."

# War risks have grown

A steady decline of Russia's conventional forces has prompted the Kremlin to rely increasingly on nuclear deterrent. Its military doctrine says it may use nuclear weapons to counter a nuclear attack on Russia or an ally, or a large-scale conventional attack that threatens Russia's existence.

<http://news.yahoo.com/russian-military-chief-war-risks-grown-140553975.html>

MEMORY TROUBLE ON THE RIGHT FLANK...

I CAN'T  
EVEN REMEMBER  
MEETING THAT  
WOMAN!

I CAN'T  
EVEN REMEMBER  
MY OWN  
NAME.

©2011  
THE ONE  
MEDIA  
11-11  
SOUTH FLA.  
SUN  
SENTINEL

CAIN

PERRY





HERMAN CAIN ACCUSED OF HARASSMENT...

HE JUST KEPT  
COMING AFTER ME,  
YELLING, "9-9-9!"  
"9-9-9!"... IT WAS  
**HORRIBLE!**

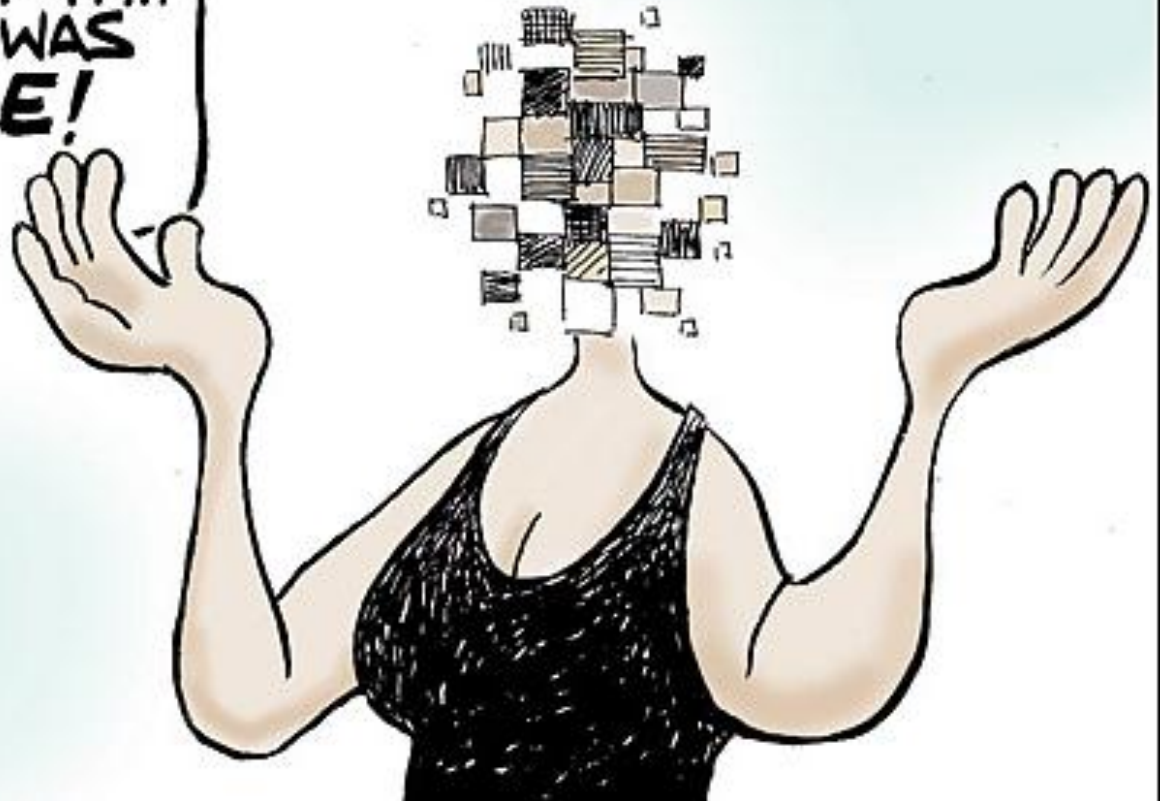

© 2011  
TRIBUNE  
MEDIA  
11-1  
SOUTH FLORIDA  
SUN SENTINEL



# OCCUPY NBA

MILLIONAIRES



BILLIONAIRES



99%



© 2011 CREATORS.COM BOKEBLUSTER.COM



## THE LATE SHOW TOP 10

"Rick Perry Excuses" as presented by Perry on *David Letterman* Thursday:

**10** Actually, there were three reasons I messed up last night: 1) was the nerves and 2) was the headache and 3) um ... uh ... oops.

**9** I don't know what you're talking about — I think things went well.

**8** I was up late last night watching *Dancing With the Stars*.

**7** I thought the debate was tonight.

**6** You try concentrating with Mitt Romney smiling at you. That is one handsome dude!

**5** Uh, El Niño?

**4** I had a five-hour energy drink six hours before the debate.

**3** I really hoped it would get me on my favorite talk show, but instead, I ended up here.

**2** I wanted to help take the heat off my buddy Herman Cain.

**1** I just learned Justin Bieber is my father.

# PERRY TRIES TO GET PAST 'OOPS' GAFFE

■ Media blitz includes everything from talk radio to late-night TV

By **RICHARD S. DUNHAM**  
and **PEGGY FIKAC**

WASHINGTON BUREAU

**TROY, Mich.** — Texas Gov. Rick Perry scrambled Thursday to rescue his damaged presidential campaign, making appearances on David Letterman's late-night comedy show, conservative talk radio shows and every television news network to explain the gaffe

that has transformed the GOP White House hopeful into the butt of jokes.

On Letterman's highly rated CBS show, Perry made fun of his "oops" moment Thursday night as part of the popular "Top Ten List" segment. His No. 1 reason: "I just learned Justin Bieber is my father."

Mixing self-deprecating humor with conservative talking points, Perry tried

## MORE INSIDE

■ Perry could come back, but few have. **PAGE A8**

■ Hart: Blunder is where the unraveling begins. **PAGE B1**

most of the day to limit the political damage from his 53 seconds of flailing during Wednesday night's GOP presidential debate, when he could not remember one of the three Cabinet departments he pledged to abolish. A YouTube clip of the episode was the most-  
*Please see* **PERRY, Page A21**

Houston Chronicle 11/11/11



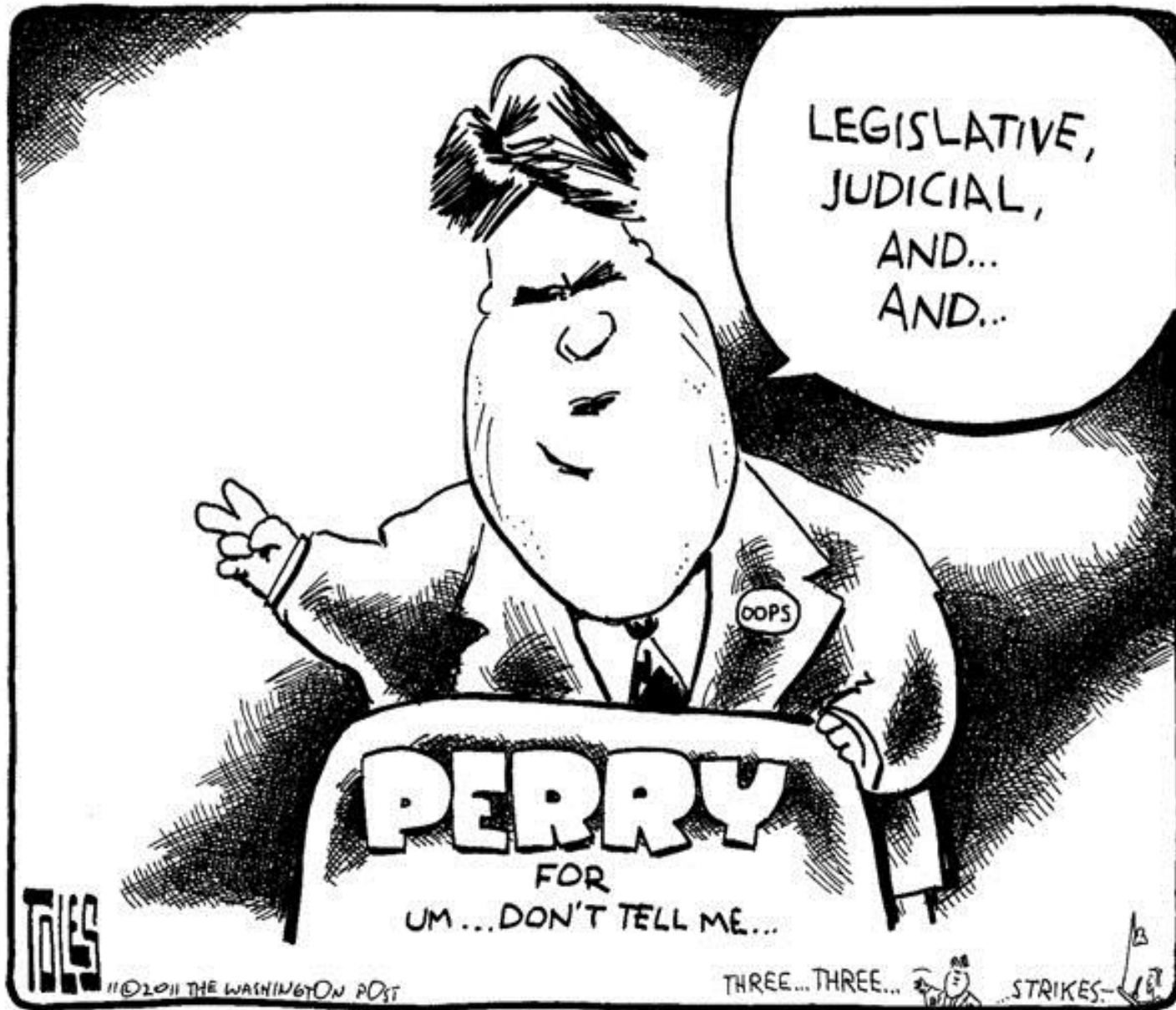





BARRELS!!!



OH, LOOK! WE'VE FOUND ANOTHER PRESIDENTIAL CANDIDATE!!

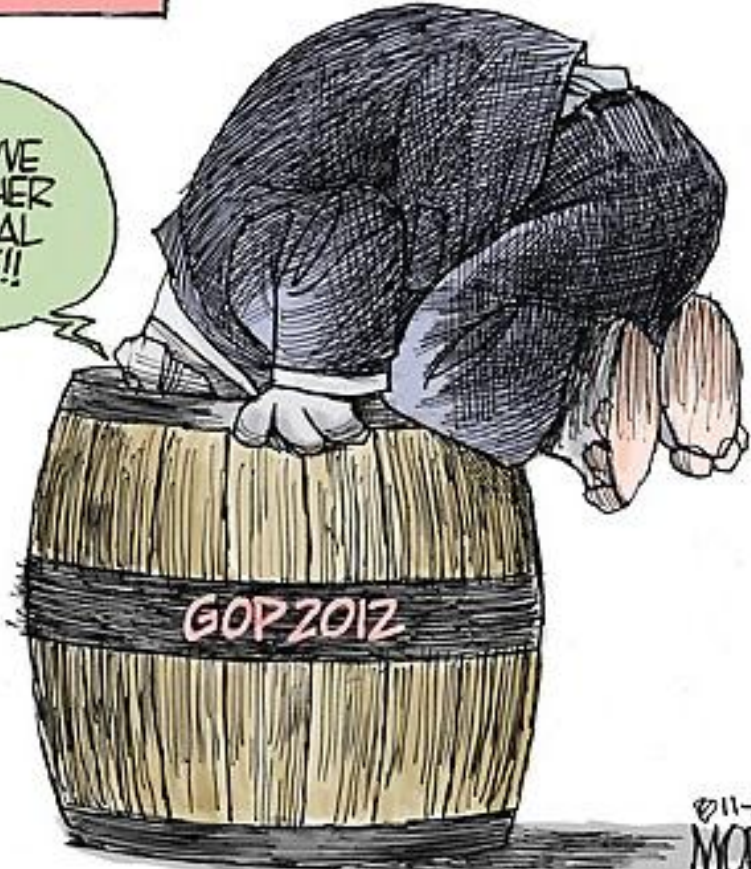

11-8-11  
MORIN  
The Miami Herald

# Generation Gap: How Age Shapes Political Outlook

<http://www.npr.org/2011/11/03/141984787/generation-gap-how-age-shapes-political-outlook>

## SELF-IDENTIFIED IDEOLOGY

- Millennial
- Gen X
- Boomer
- Silent

### Conservative

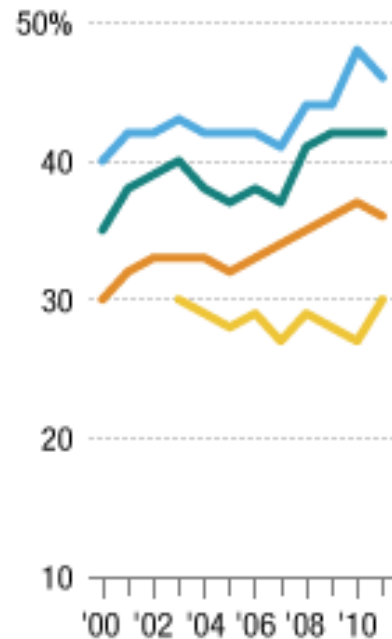

### Moderate

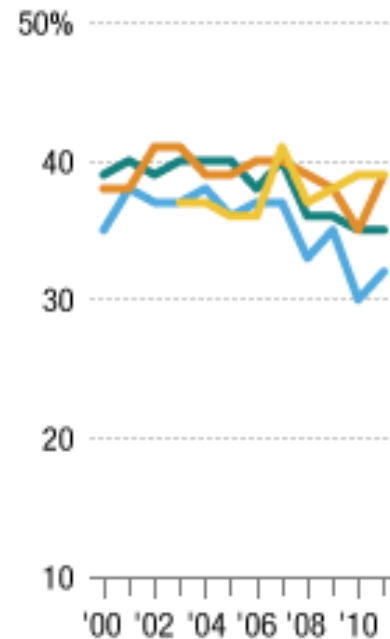

### Liberal

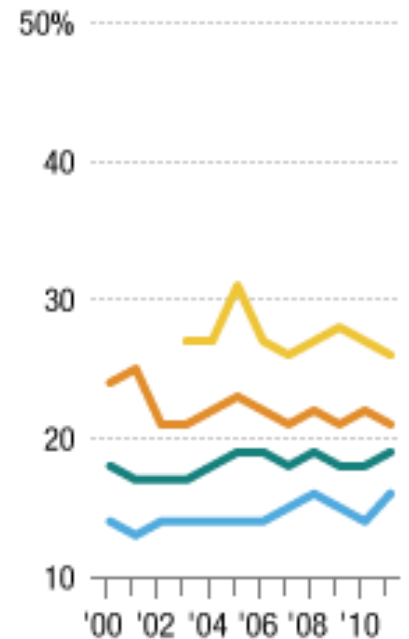

# The Generation Gap and the 2012 Election

## Angry Silents, Disengaged Millennials

November 3, 2011

**Young-Old Voting Gap Largest Since Nixon v. McGovern in 1972**

Percent voting for Democratic candidate

Young-Old Gap

+16 +4 +3 +1 -2 -7 +3 -2 +7 +21 +20

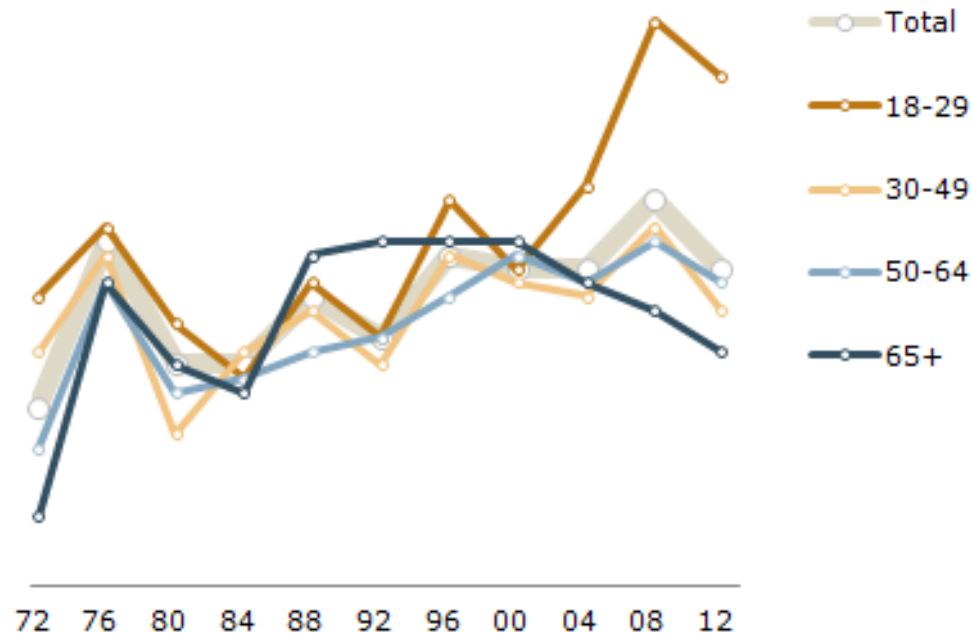

PEW RESEARCH CENTER Sept. 22-Oct. 4, 2011. 1972-2010 data from national exit polls. 2012 preference based on registered voters. Age breaks for 1972-1988 are 18-29, 30-44, 45-59, and 60+.

Republicans, who is the man  
behind the curtain that your  
Senators and Representatives

*FEAR?*



Doctor NO! (NOrquist that is) →



# Grover Norquist: GOP leaders will listen to my marching orders



It's hard to know whether Norquist is merely inflating his own influence here — he does seem to have a well-cultivated egomaniacal streak — [Greg Sargent](#)

# Enter the Zombie

*Has your Republican turned control of his mind over to the master ideologue ...*





19 November 2011

War, Taxes and Debt

35



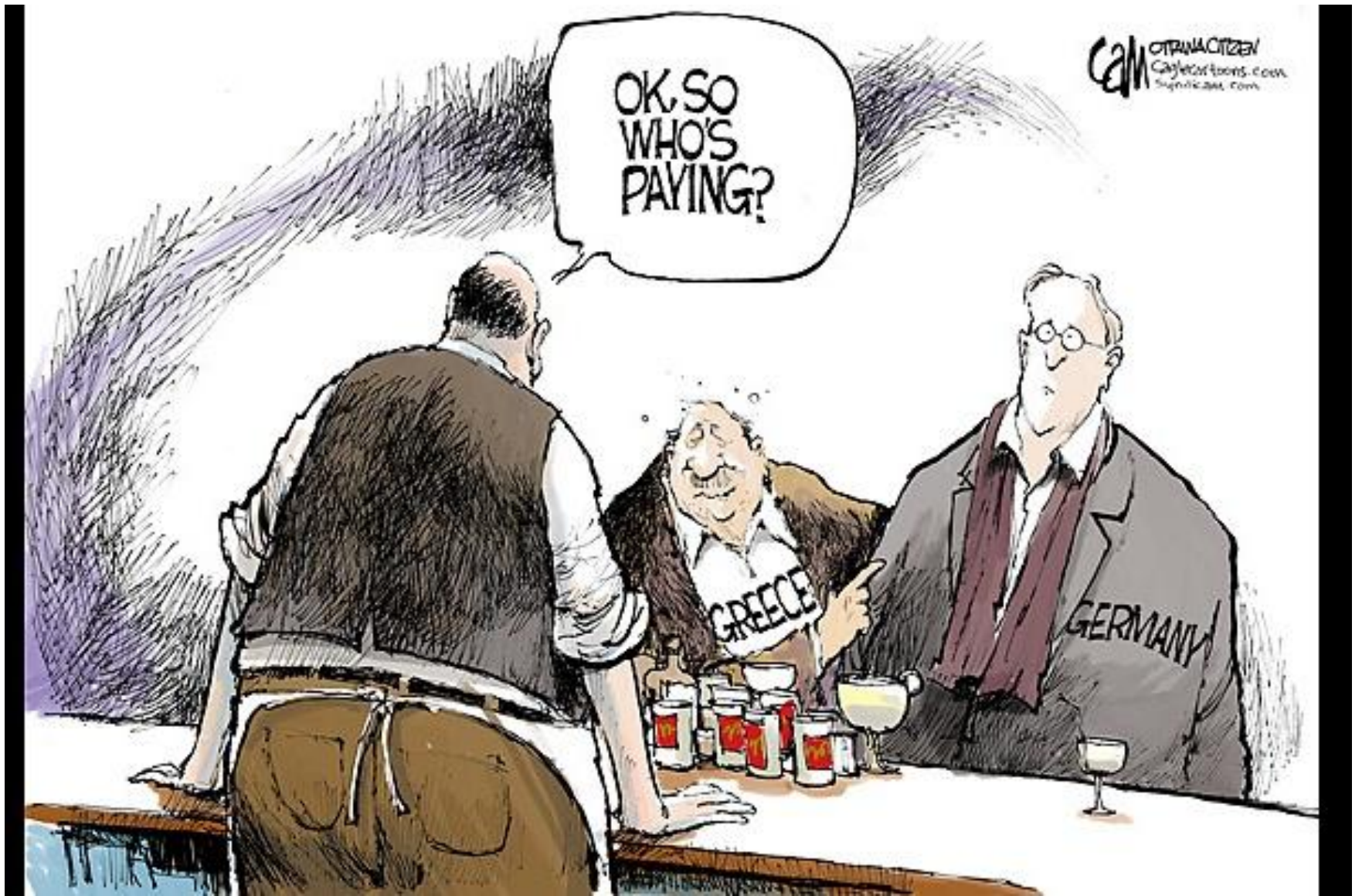

# **Subject: Greek economy explained.**

**Some years ago a small rural town in Italy twinned with a similar town in Greece...**

**The Mayor of the Greek town visited the Italian town. When he saw the palatial mansion belonging to the Italian mayor he wondered how he could afford such a house. The Italian said; "You see that bridge over there? The EU gave us a grant to build a two-lane bridge, but by building a single lane bridge with traffic lights at either end this house could be built".**

# **Greek economy explained**

**The following year the Italian visited the Greek town. He was simply amazed at the Greek Mayor's house, gold taps, marble floors, it was marvelous.**

**When he asked how this could be afforded the Greek said; "You see that bridge over there?"**

**The Italian replied; "No."**

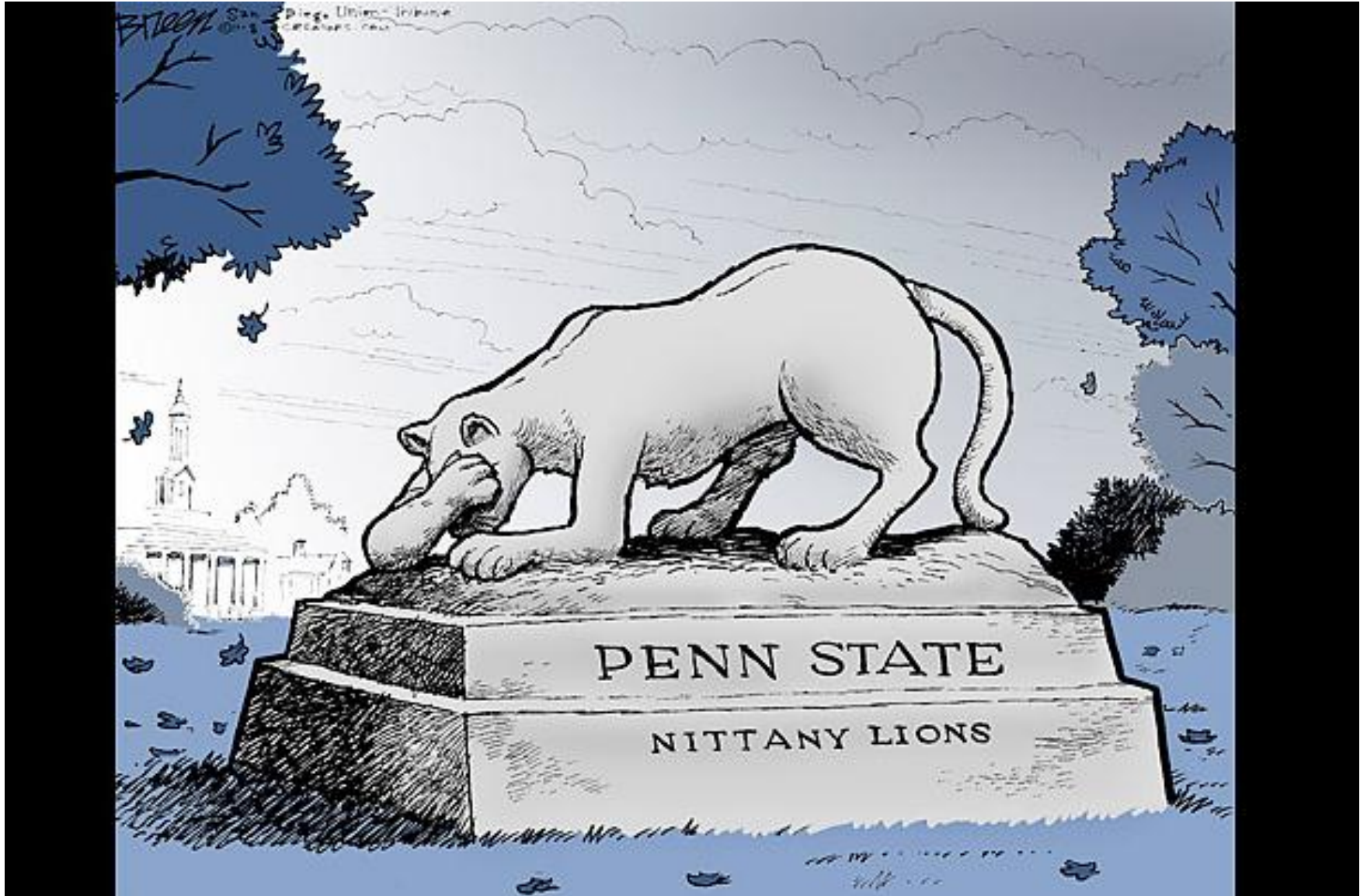





PENN STATE  
FOOTBALL'S  
LEGENDARY  
REPUTATION

NICK ANDERSON  
© 11-9-11 HOUSTON CHRONICLE





19 November 2011

War, Taxes and Debt

41

# Joe Paterno's Sex Abuse Mess: What Took the Media So Long?

By Brent Lang & Lucas Shaw at [TheWrap](#) Fri Nov 11, 2011 5:39am EST

When Penn State fired head coach Joe Paterno on Wednesday, it was the culmination of a scandal more than 15 years in the making. So what took the media so long

... it was a pair of enterprising metro reporters that broke open the Watergate scandal -- not a White House reporter.

The big sports scandals in recent years, in particular the Barry Bonds-steroids case, were broken by seasoned investigative journalists. Sadly, those professionals are an endangered in 2011.

<http://www.reuters.com/article/2011/11/11/idUS338282843420111111>

# What took so long?

"The past 5, 10 years there has been this veil of secrecy at the school that goes beyond even hiding or dealing with major stories like this," Quinn said. "They don't give access to practice."

Not only did Penn State try to suppress the story, but according to Newhouse, police discouraged potential victims from involving the media.

As far back as 1998, Newhouse claims state police told the mother of one of Sandusky's apparent victims not to discuss the case with journalists.

All of these factors explain why, despite an uncertain number of victims, despite an attorney general investigation that began two years ago, despite numerous articles this year from the Patriot-News, the story did not break until Nov. 4 of this year.

# Yeah...that's a good question.”

When things finally did crack open, however, the media frenzy and the onslaught of new and ever more sordid details could not be contained. In a matter of five days an inviolable coach and a sacrosanct football program have had their reputations atomized.

“What surprised me is just that there wasn't a bigger national story earlier,” McBride said. “As I look at it, I still don't know exactly why that was.”

Or as Weinreb said: “Yeah...that's a good question.”

<http://www.reuters.com/article/2011/11/11/idUS338282843420111111>

# Veterans Days

FORN... INVESTOR'S BUSINESS ONLY  
2011 © CASIATOPIC.COM

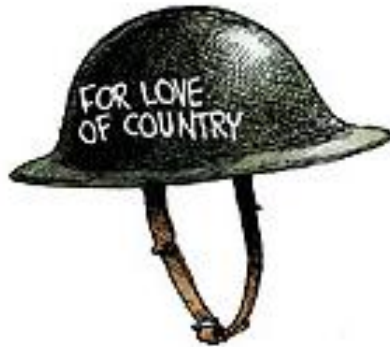

THANK YOU

[www.investors.com/cartoons](http://www.investors.com/cartoons)



# Troops unload from a CH-47 helicopter in the Cay Giep Mountains, Vietnam, 1967.



# Advanced Threat Infrared Countermeasure/Common Missile Warning System (ATIRCM/CMWS)



27

## Advanced Threat Infrared Countermeasure/Common Missile Warning System (ATIRCM/CMWS)

**FOREIGN MILITARY SALES**  
United Kingdom

**CONTRACTORS**  
**ATIRCM/CMWS (Prime):**  
BAE Systems (Nashua, NH)  
**Logistics Support:**  
AEPKO (Huntsville, AL)  
**Software Configuration Management Support:**  
Science Applications International Corp. (SAIC) (Huntsville, AL)  
**CMWS-GTRI E2E Data Analysis/SIL Development:**  
Georgia Tech Applied Research Corp. (Atlanta, GA)  
**OH-58D Product Documentation Update:**  
Bell Helicopter Textron (Fl. Worth, TX)  
**Test Support Data Analysis:**  
MacAulay-Brown Inc. (Dayton, OH)  
**UH-60A/L P3H Upgrade:**  
Rockwell Collins (Cedar Rapids, IA)  
**Engineering/Tech Production Support:**  
Computer Sciences Corp. (CSC) (Huntsville, AL)  
**OATS Phase 3:**  
David H. Pollock Consultants (Eatontown, NJ)



WEAPON SYSTEMS 2012

# **ATIRCM**

**ATIRCM Quick Reaction  
Capability (QRC), the Army's latest  
Aircraft Survivability Equipment (ASE)  
initiative to protect crews and aircraft  
from advanced threat Man-Portable  
Air Defense Systems (MANPADS)**



# MANPADS

**Man-portable air-defense systems (MANPADS or MPADS)** are shoulder-launched surface-to-air missiles (SAMs). They are typically guided weapons and are a threat to low-flying aircraft, especially helicopters.



# RPG Rocket Propelled Grenade

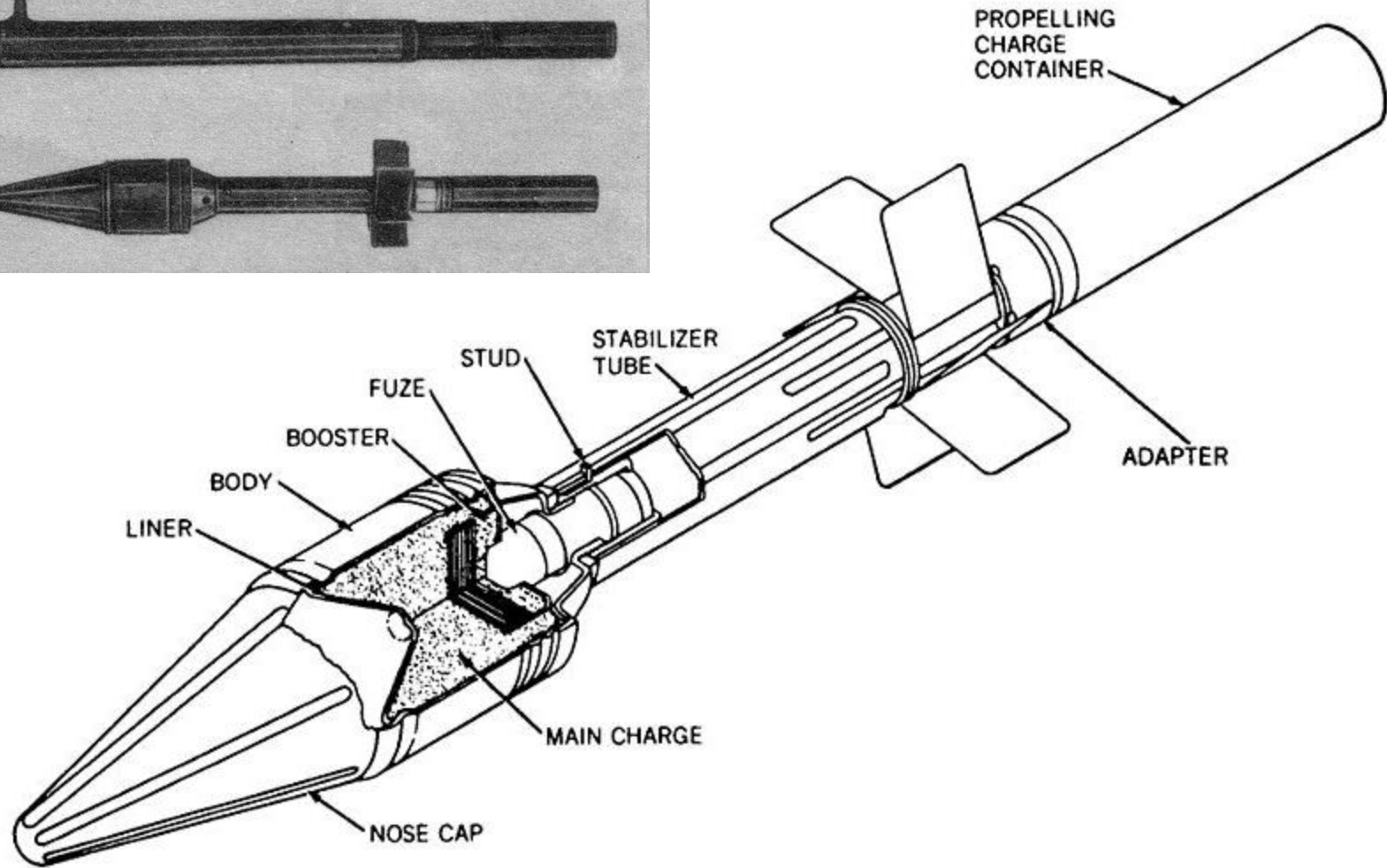
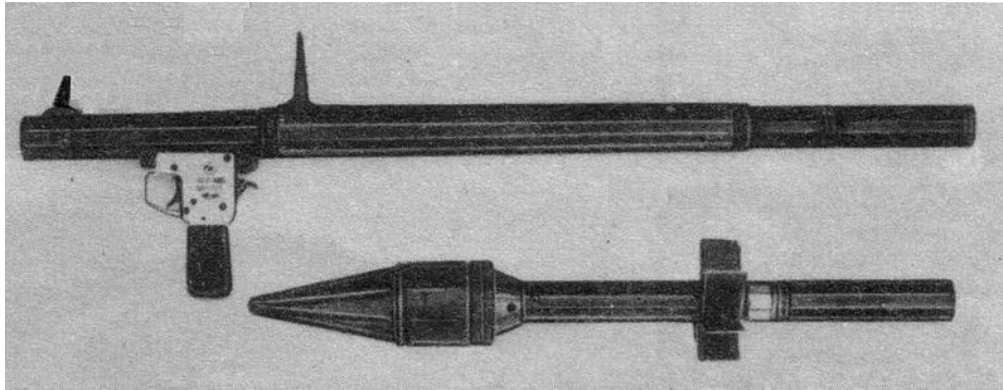

# **The Bonus Army: How A Protest Led To The GI Bill** by Radio Diaries

## **The Bonus Army**

**As World War I drew to a close in 1918, millions of American veterans returned home to the promise of a cash bonus — compensation for their overseas service.**

**There was a catch, though: The money would not be paid out until 1945.**

**Then, the Great Depression struck. Millions of Americans were left hungry and homeless. Veterans of the war were desperate for relief.**

**So in 1932, a group of veterans in Portland, Ore., led by a man named Walter Waters, decided to go to Washington to lobby for early payment of their promised bonus.**

**They went down to the railroad yards, with a bugle and an American flag, and hopped onto freight trains. They called themselves the Bonus Army.**

<http://www.npr.org/2011/11/11/142224795/the-bonus-army-how-a-protest-led-to-the-gi-bill>

*...a whole lot of people speak of you as tramps.*

Makes me so damn mad, a whole lot of people speak of you as tramps. By God, they didn't speak of you as tramps in 1917 and '18. Take it from me, this is the greatest demonstration of Americanism we have ever had.

- Retired Marine Corps Gen. Smedley Butler

## **Army Attacks The Camp**

Officials in Washington expected that the Bonus Marchers would all go home. But they didn't. The numbers dropped, but the hard core among them stayed. And there was no indication they were ever going to leave.

The situation quickly spiraled out of control, and the Hoover administration sent in the Army, led by Gen. Douglas MacArthur.

Four years later, the WWI vets received their bonuses. And in 1944,

Congress passed the GI Bill

# AARP's Analysis

on the national debt

## CHOPPING BLOCK?



### Medicare: Where Experts Think Congress May Look for Savings

A rundown of the kindest cuts the debt supercommittee could consider. [Read](#)



### Medicare, Medicaid: 8 Things the Super-Committee Could Do

A blow-by-blow rundown of the cuts in benefits that Congress could make. [Read](#)



### Social Security: 3 Big Things the Super-Committee Could Do

Change the cost-of-living adjustment. Add a means test. Increase the retirement age. [Read](#)

### Social Security: COLAs in the Crosshairs

Changes in how cost-of-living adjustments are calculated could result in shrinking payments for millions of older Americans. [Read](#)

### Too Much to Cut, Too Little Time?

Tight timetable, contentious politics, market turmoil and an ever-bigger budget make the super-committee's job super-difficult. [Read](#)

<http://www.aarp.org/policies/social-security/government-decisions/all-about-national-debt-federal-deficit/>

# **EXCLUSION OF SOCIAL SECURITY FROM ALL BUDGETS**

**Pub. L. 101-508, title XIII, Sec. 13301(a), Nov. 5, 1990, 104Stat. 1388-623, provided that:**

**Notwithstanding any other provision of law, the receipts and disbursements of the Federal Old-Age and Survivors Insurance Trust Fund and the Federal Disability Insurance Trust Fund shall not be counted as new budget authority, outlays, receipts, or deficit or surplus for purposes of - (1) the budget of the United States Government as submitted by the President, (2) the congressional budget, or (3) the Balanced Budget and Emergency Deficit Control Act of 1985.**

# "Social Security Trust Fund"

The trust funds run surpluses in that the amount paid in by current workers is more than the amount paid out to current beneficiaries. These surpluses are given to the [U.S. Treasury](#) (and thus become part of the general federal budget) in exchange for special U.S. government securities, which are deposited into the trust funds. **If the trust funds begin running deficits, meaning more in benefits are paid out than contributions paid in, the Social Security Administration is empowered to redeem the securities and use those funds to cover the deficit.**

[http://en.wikipedia.org/wiki/Social\\_Security\\_Trust\\_Fund](http://en.wikipedia.org/wiki/Social_Security_Trust_Fund)

\$ 043,699,231,093,828

CURRENT GLOBAL PUBLIC DEBT

Public debt per person

Higher debt Lower debt

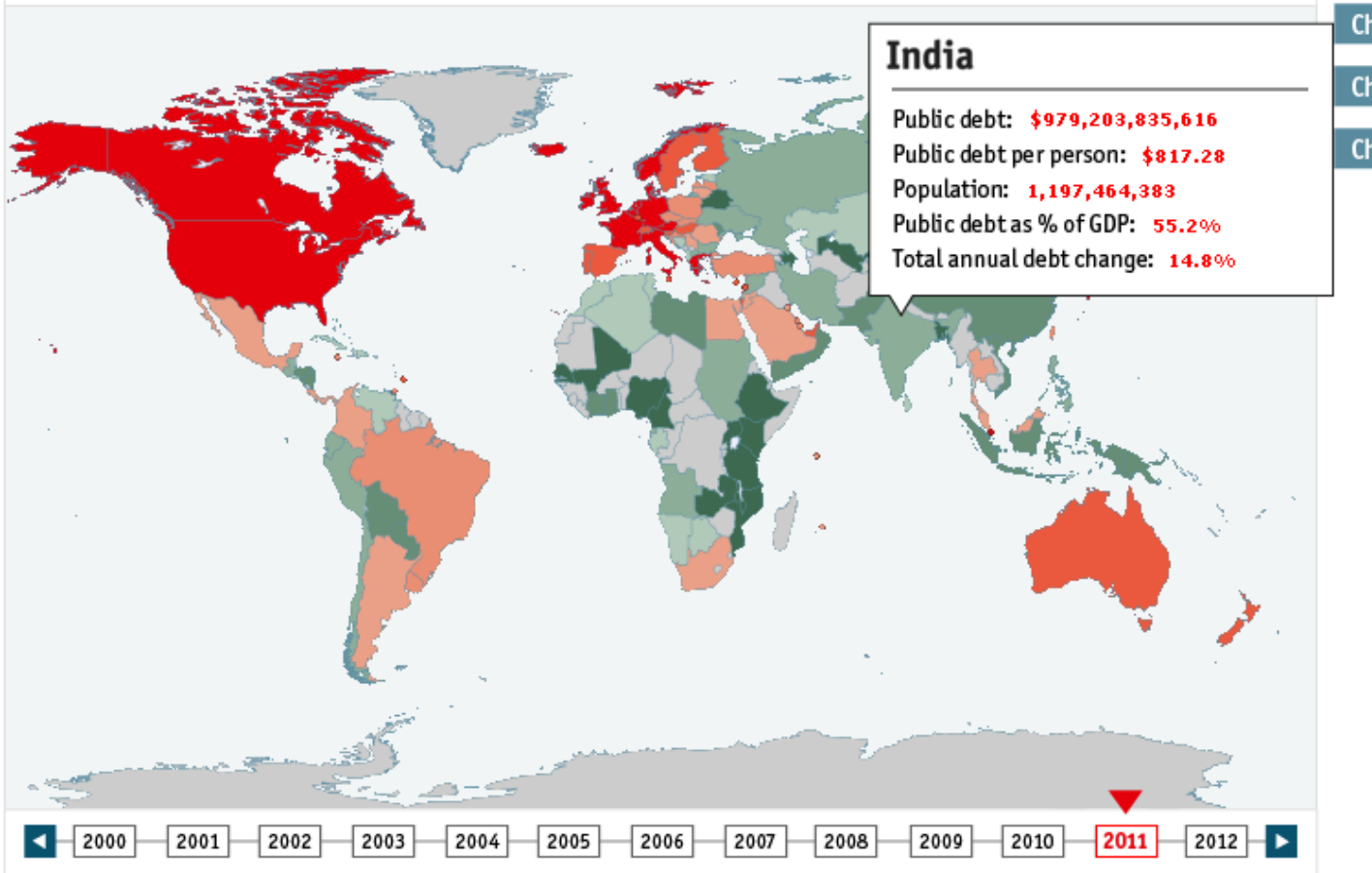



[http://www.investmenttools.com/thefed/federal\\_reserve\\_free\\_reserves.htm](http://www.investmenttools.com/thefed/federal_reserve_free_reserves.htm)

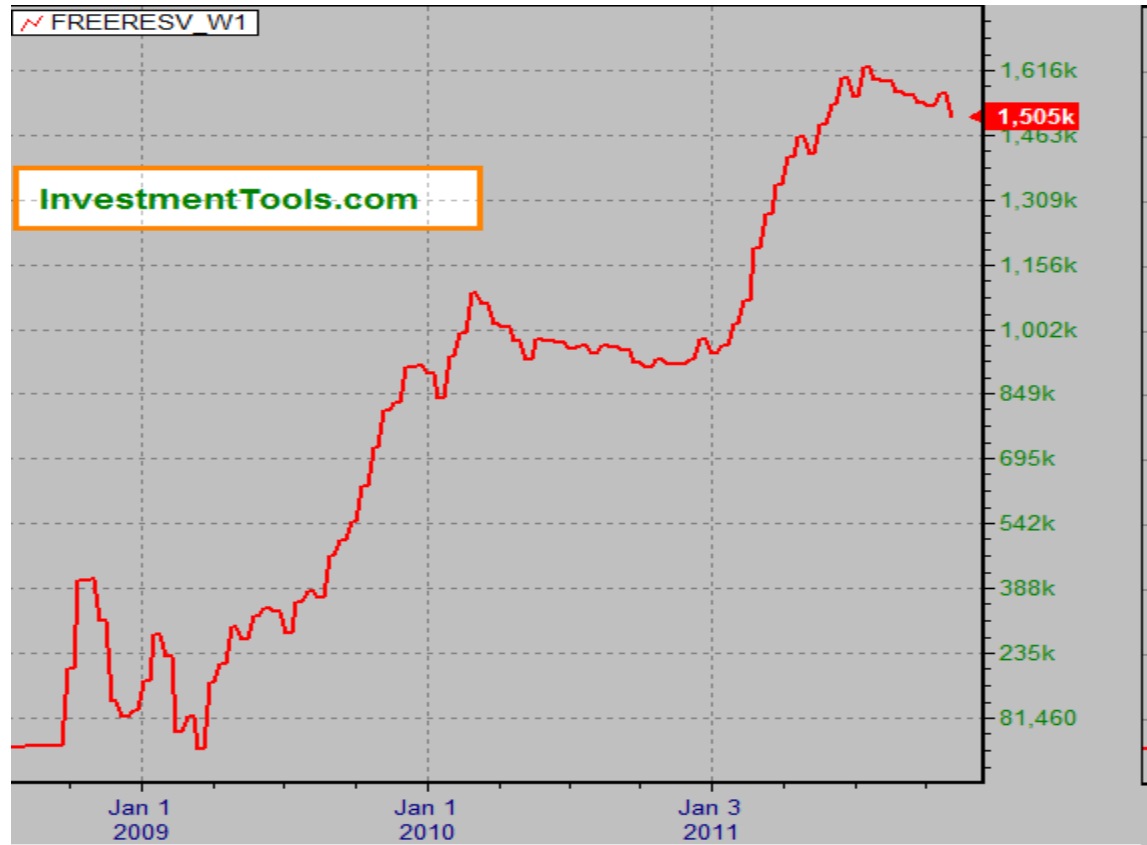
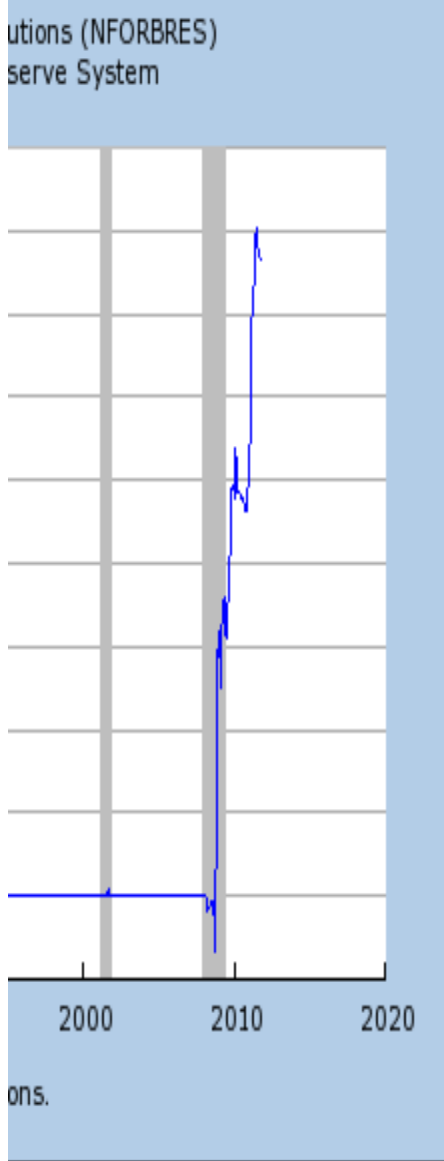

Chart created with NeoTicker EOD © 1998-2007 TickQuest Inc.

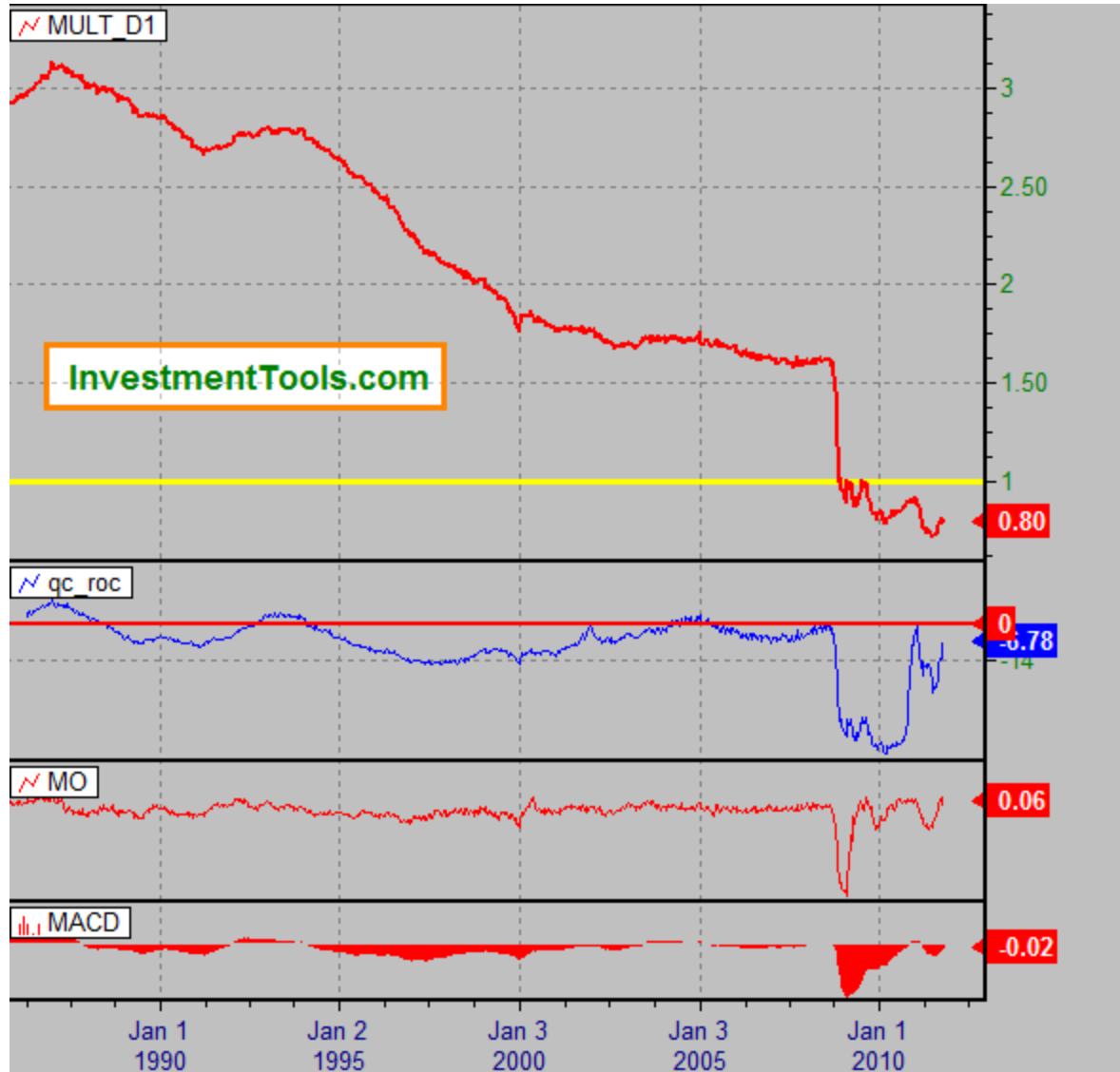

Chart created with NeoTicker EOD © 1998-2007 TickQuest Inc.



### SPDR S&P 500 (NYSEArca: SPY)

AdChoices

After Hours: 122.12 ↑ 0.14 (0.12%) 7:59PM EST

Last Trade:	<b>121.98</b>	Day's Range:	121.47 - 122.75
Trade Time:	4:00PM EST	52wk Range:	107.43 - 137.18
Change:	<span style="color: red;">↓ 0.13 (0.10%)</span>	Volume:	215,580,353
Prev Close:	122.11	Avg Vol (3m):	277,861,000
Open:	122.50	YTD Return (Mkt) <sup>2</sup> :	1.18%
Bid:	122.07 <span style="color: blue;">↑ 100</span>	Net Assets <sup>2</sup> :	90.88B
Ask:	122.15 <span style="color: blue;">↑ 200</span>	P/E (ttm) <sup>2</sup> :	13
AVG <sup>1</sup> :	116	Yield (ttm) <sup>2</sup> :	1.96

# Sun Spots

ISES Solar Cycle Sunspot Number Progression  
Observed data through Oct 2011

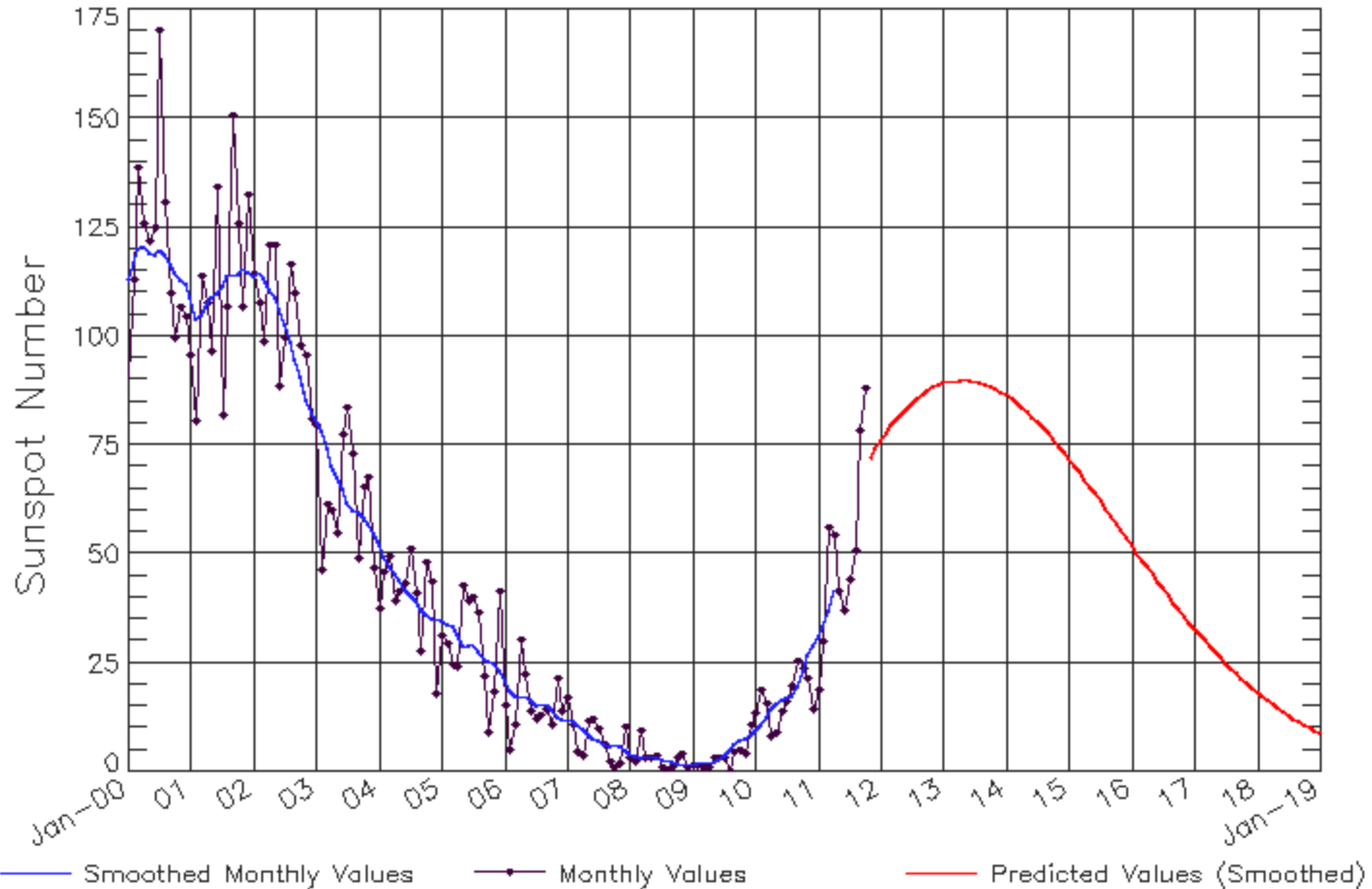

Updated 2011 Nov 8

<http://www.swpc.noaa.gov/solarcycle/>

NOAA/SWPC Boulder, CO USA

**Flying over what appears to be New Hampshire's Lakes Region, these 82nd FG F-51Ds were equipped with 165 gal. drop tanks. The group often flew Very Long Range (VLR) missions as directed by SAC. Photo courtesy Bob Fogg**



<http://www.vermontel.net/~tomh/AIRCRAFT/AIRPORTS/MHT/82FG.html#B1>





**Third Saturday Seminar 2011-2012**

**Humanity at a Crossroads**

**Session 03**

**19 November 2011**

**Next - Main Presentation**

**War, Taxes and Debt**

**Colin J. N. Chauret, Col., USAF (Ret.)**

**ALL Program, Lone Star College - Montgomery, Conroe,  
Texas**

# **Don't panic!**

## ***Don't be Panicked!***

# **Welcome back to interesting times !**



## **See You Next Time**

The Monty Python Foot, a convenient way to end something that would seem to go on for ever accomplishing nothing.... (*See deus ex machina*)

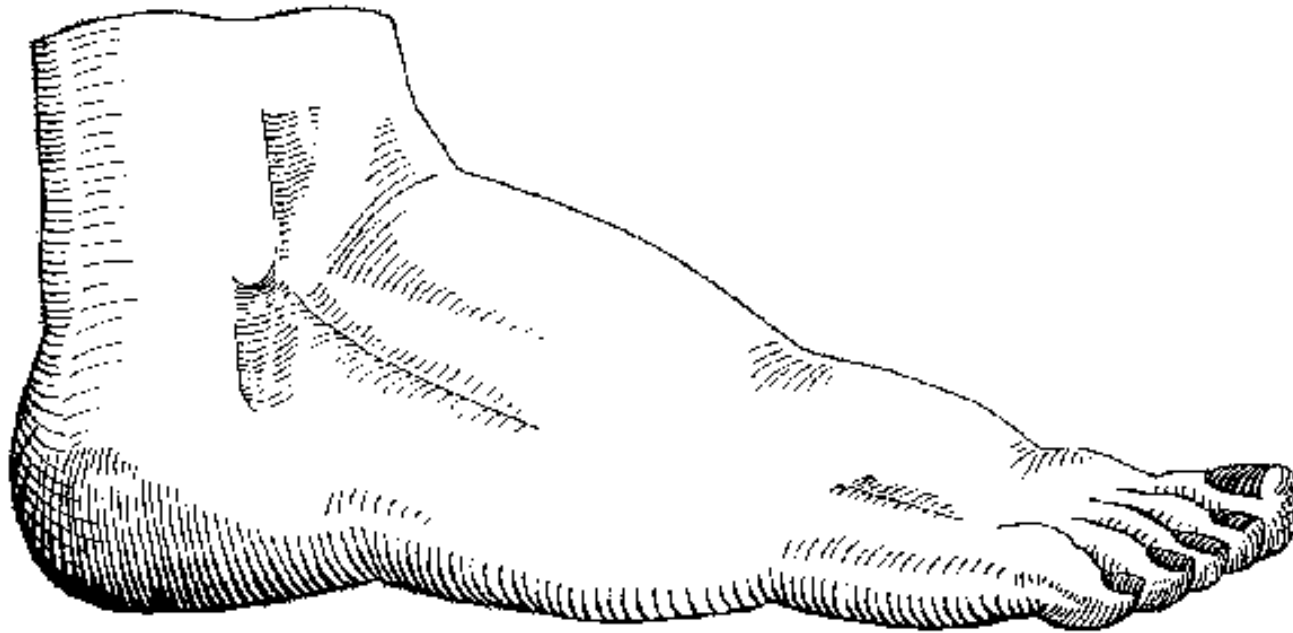

The famous Python Foot can here be seen in its original format in the bottom left corner of "An Allegory of Venus and Cupid" by [Bronzino](#) (~1545)

When Monty Python had no ending for a skit, this foot would appear out of the sky and squash whatever was on screen with a rude noise. Allowing the show to move on.

# Enrichment Material



# What makes you an Authority?

The word authority comes from the word *author*. And the word author has a Latin root. It means: “he who enables growth”.

So, the person whom you recognize as an authority is a person who enables your growth.

The others are the ones to decide if I am an authority to them or not.

## **What makes you an Authority?**

Your personal abilities:

1. Your Inner Power
2. Your knowledge

## **Authority and Inner Power:**

I just said the true Authority is the result of your Inner Power.

This means I would judge your sense of Authority as your Inner Power.

<http://www.luismartinssimoes.com/2009/07/how-to-be-respected/>

# Authority and Inner Power:

Yet, most people will judge your authority by **how you appear** and **how you act**.

We could call this your intrapersonal intelligence and your interpersonal intelligence.

People will confuse your Inner Power with your appearance and your acts, which are part of the ego.

This means that may you be totally genuine or totally faked, you will be an authority for someone.

Some will like a person's big ego and strong personality.

And he will be considered as an authority to them. That's their choice.

Some others will prefer another person's genuine vibration and ability to connect and recognize the source, and he will be considered as an authority to them.

It's always the others' choice.

<http://www.luismartinssimoes.com/2009/07/how-to-be-respected/>

# Authority and Knowledge:

You can be considered an authority for thousands of characteristics:

It can be because you are a good listener, or because you react calmly and softly to others' fragilities, or because you are good at saying, "No," or because you have no fears, or because you verbalize and observe your emotions...

If you are an individual who is very much identified with your ego, you will recognize authority to egotistic people.

If you are an individual who prefers to connect to the Source, to the I Am, you will recognize authority in spiritual people, for example, but not in egotistic people.

## Authority and Knowledge:

Your knowledge is your ability to master [Instruction on Matter](#).

People will like your knowledge in Economy, or in Finance, or in Law, or in Philosophy, or in Engineering, or in Astrology, or in Painting...

**This means authority does not claim for obedience, never!**

Only someone who feels that his authority may be at stake will claim for obedience thru the use of power.

**Power inspires fear.**

**Authority inspires respect.**

<http://www.luismartinssimoes.com/2009/07/how-to-be-respected/>

# **RETURN of the ELDERS UNLEASH YOUR WISDOM**

**It's time for the Return of the ELDERS! Previous successful societies relied on the councils of their ELDERS to offer WISDOM in times of confusion. Folks, we can't quit yet.**

# What does Authority mean?

The true Authority is the result of your inner power. It's the wisdom that comes from within.

It has to do with your connection [to the source, to the I Am](#).

Authority has nothing to do with the verb to have, but rather with the verb to be.

You do not have authority. You are seen as an authority.

The big difference between the External Power and Authority lies in the fact that authority cannot be imposed, it needs to be recognized.

So your authority depends on those who look at you.

Some people may recognize your authority and some others may not.

And you cannot do anything about it.

This is why people who are very much identified with their ego, and thus seeking for others approval, can't stand those who do not recognize their authority and hence use power to submit them by force.

<http://www.luismartinssimoes.com/2009/07/how-to-be-respected/>



# Accepting the challenge

Many of you have in fact made real contributions during your lifetimes and careers. And now you feel you have earned a rest and start cashing in your chips and enjoying the good life.

Not so fast, I'm afraid. We still have work to do if we are going to still have the America we thought we were going to have, but we see disappearing.

**One of life's persistent questions:**

**“Why do cockroaches roll over before the die?”**



# Mazlow's Hierachy of Needs

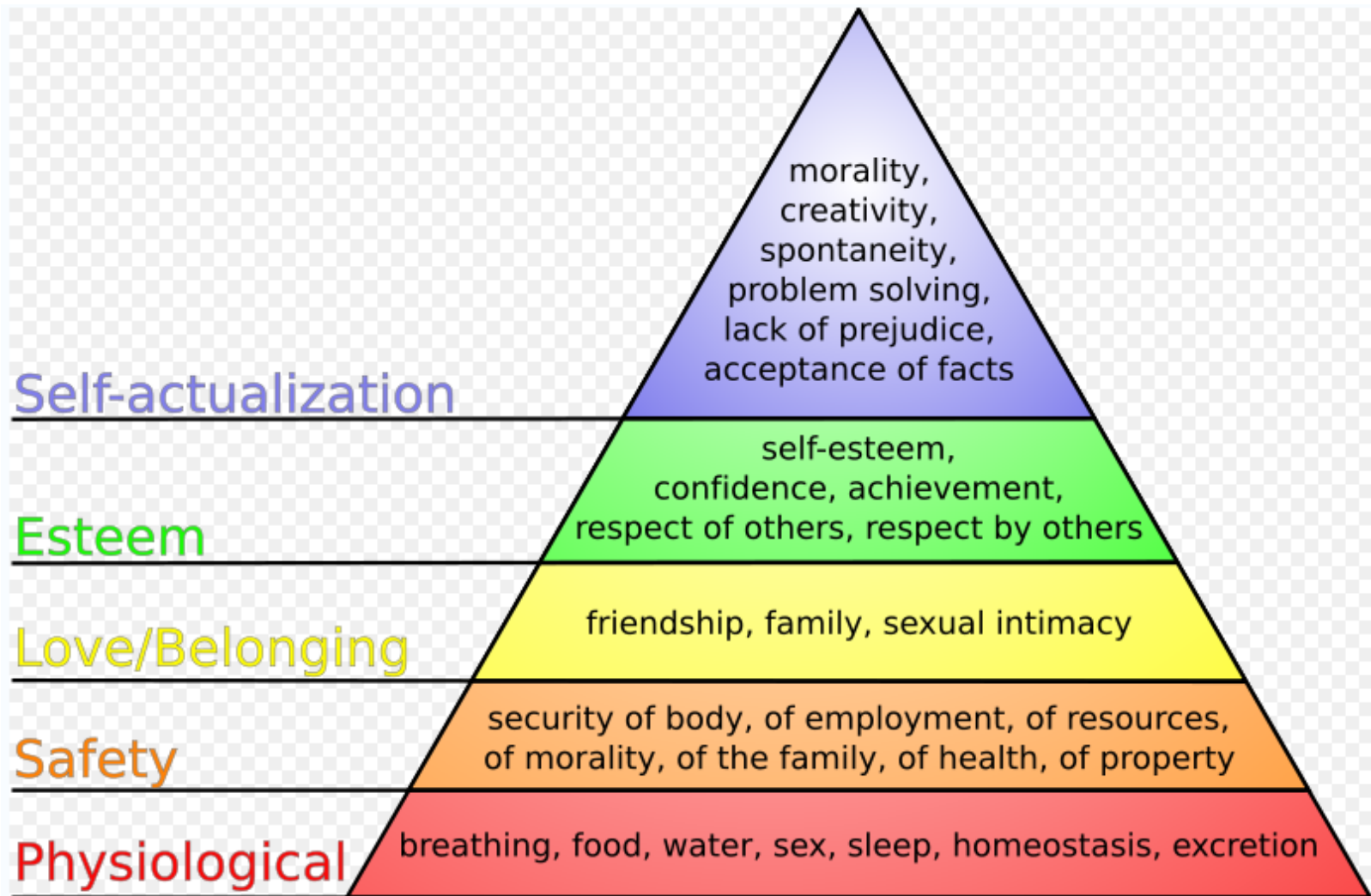

[Maslow's\\_hierarchy\\_of\\_needs.svg](#) (SVG file, nominally 1,717 × 1,124 pixels, file size: 8 KB)

# **It all connects**

**Fear, War, Greed**

**To much capital in the hands of the few**

**Too little money in the hands of the consumers.**

**Credit is not a replacement for disposable income**

**Oil is a limited resource**

**Unable to anticipate what looks obvious in retrospect**

**Trusting of Authority**

**Lacking critical ability/Education**

**Etc.**

# The Years of the Great Depression

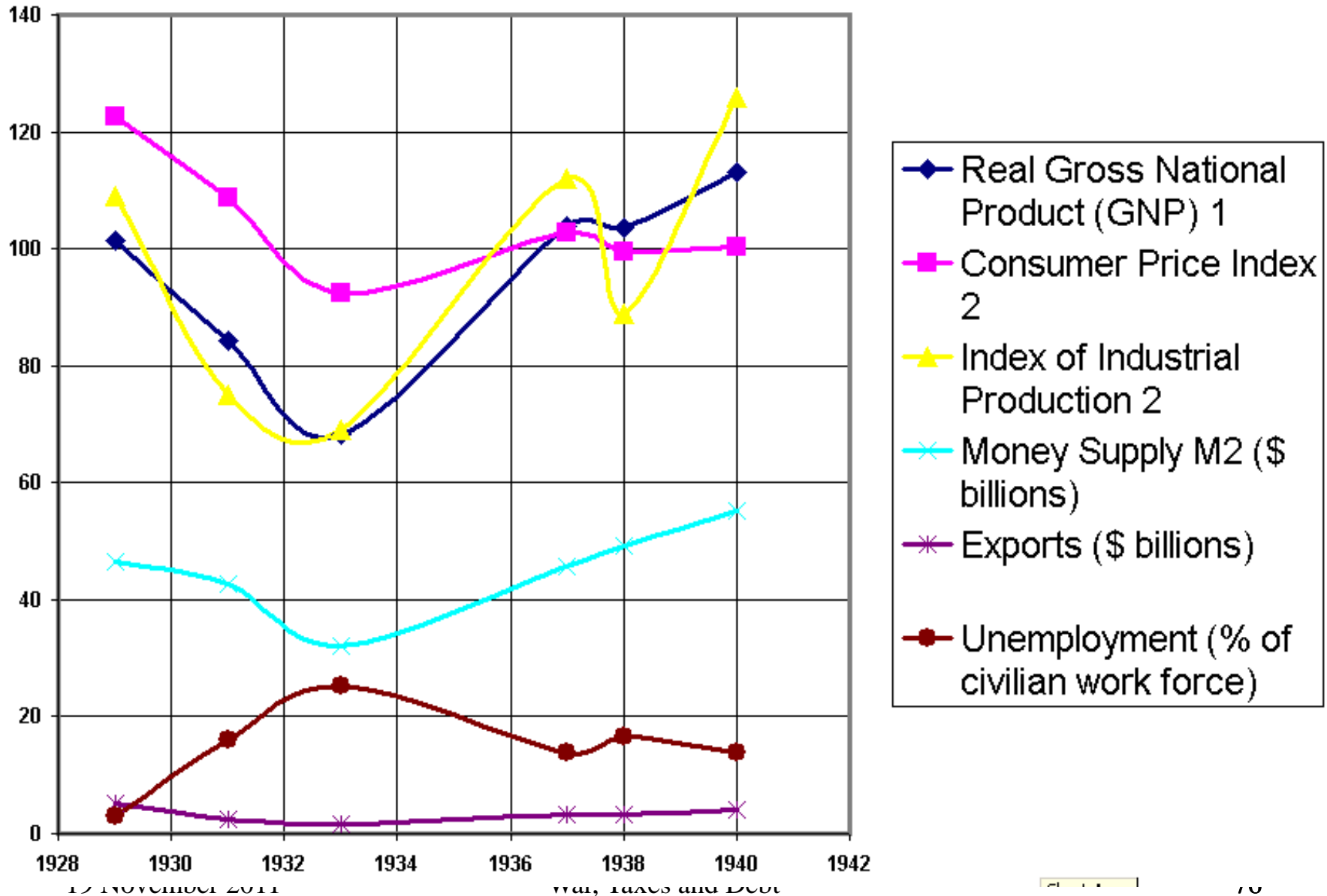

# **Don't just be a thermometer, Be a thermostat**

**Jill Carroll**



**“...we are the leaders we've  
been looking for.”**

*Grace Lee Boggs*

# Basic Wilderness Survival Skills

## From: **British Columbia Outdoor Wilderness Guide**

**Fear** - For anyone faced with a wilderness emergency survival situation, fear is a normal reaction. Unless an emergency situation has been anticipated, fear is generally followed by panic then pain, cold, thirst, hunger, fatigue, boredom and loneliness. It is extremely important to calmly assess the situation and not allow these seven enemies to interfere with your survival.

**Pain** - Pain may often be ignored in a panic situation. Remember to deal with injuries immediately before they become even more serious.

**Cold** - Cold lowers the ability to think, numbing the body and reducing the will to survive. Never allow yourself to stop moving or to fall asleep unless adequately sheltered.

**Thirst** - Dehydration is a common enemy in an emergency situation and must not be ignored. It can dull your mind, causing you to overlook important survival information.

**Hunger** - Hunger is dangerous but seldom deadly. It may reduce your ability to think logically and increase your susceptibility to the effects of cold, pain and fear.

**Fatigue** - Fatigue is unavoidable in any situation so it is best to keep in mind that it can and will lower your mental ability. Remember that in an emergency situation this is often the body's way of escaping a difficult situation.

**Boredom & Loneliness** - These enemies are quite often unanticipated and may lower mind's ability to deal with the situation.

<http://www.ngdc.noaa.gov/stp/geomag/image/apstar07.jpg>

### Number of Days $A_p^* \geq 40$ 1932 - 2007

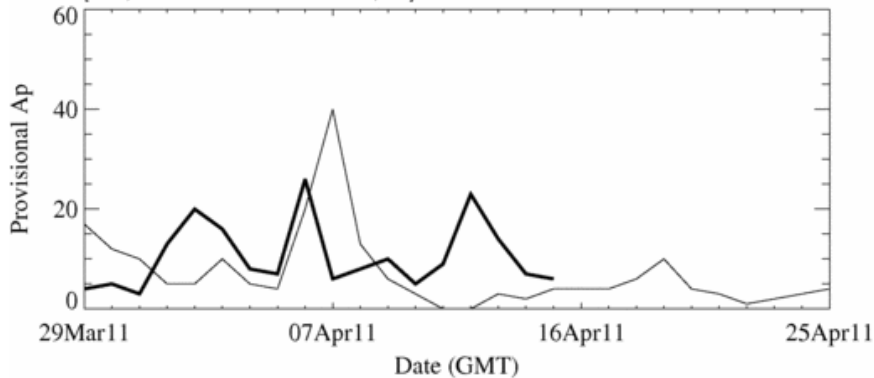
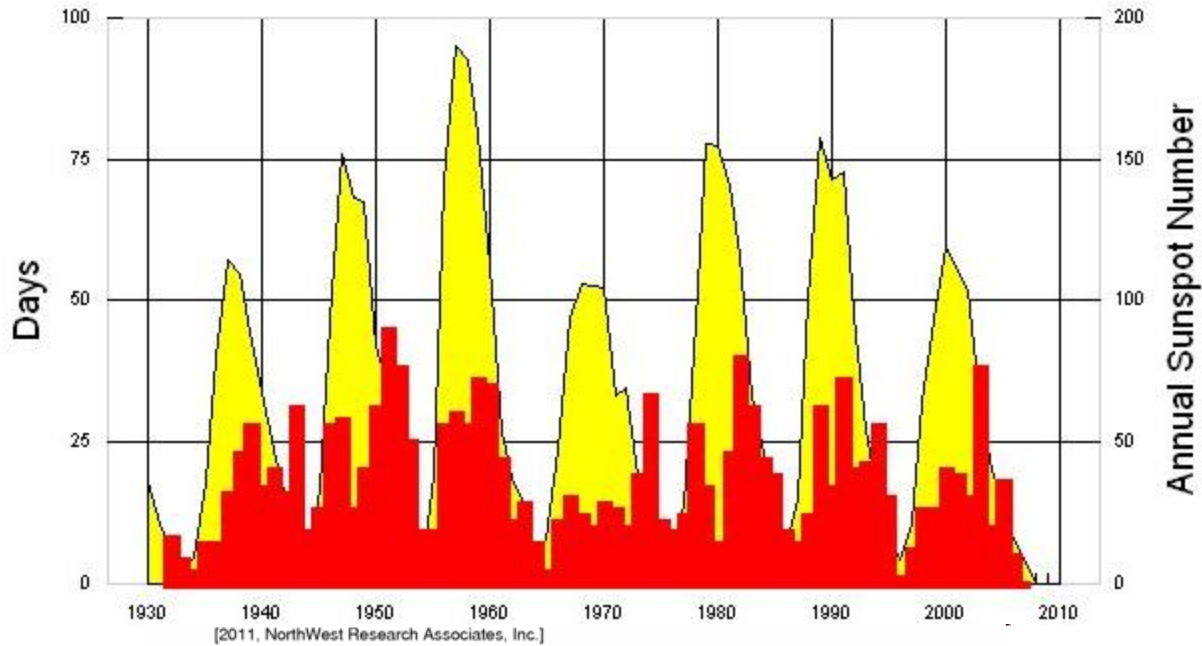

# <http://www.swpc.noaa.gov/SolarCycle/>

ISES Solar Cycle Ap Progression  
Observed data through Mar 2011

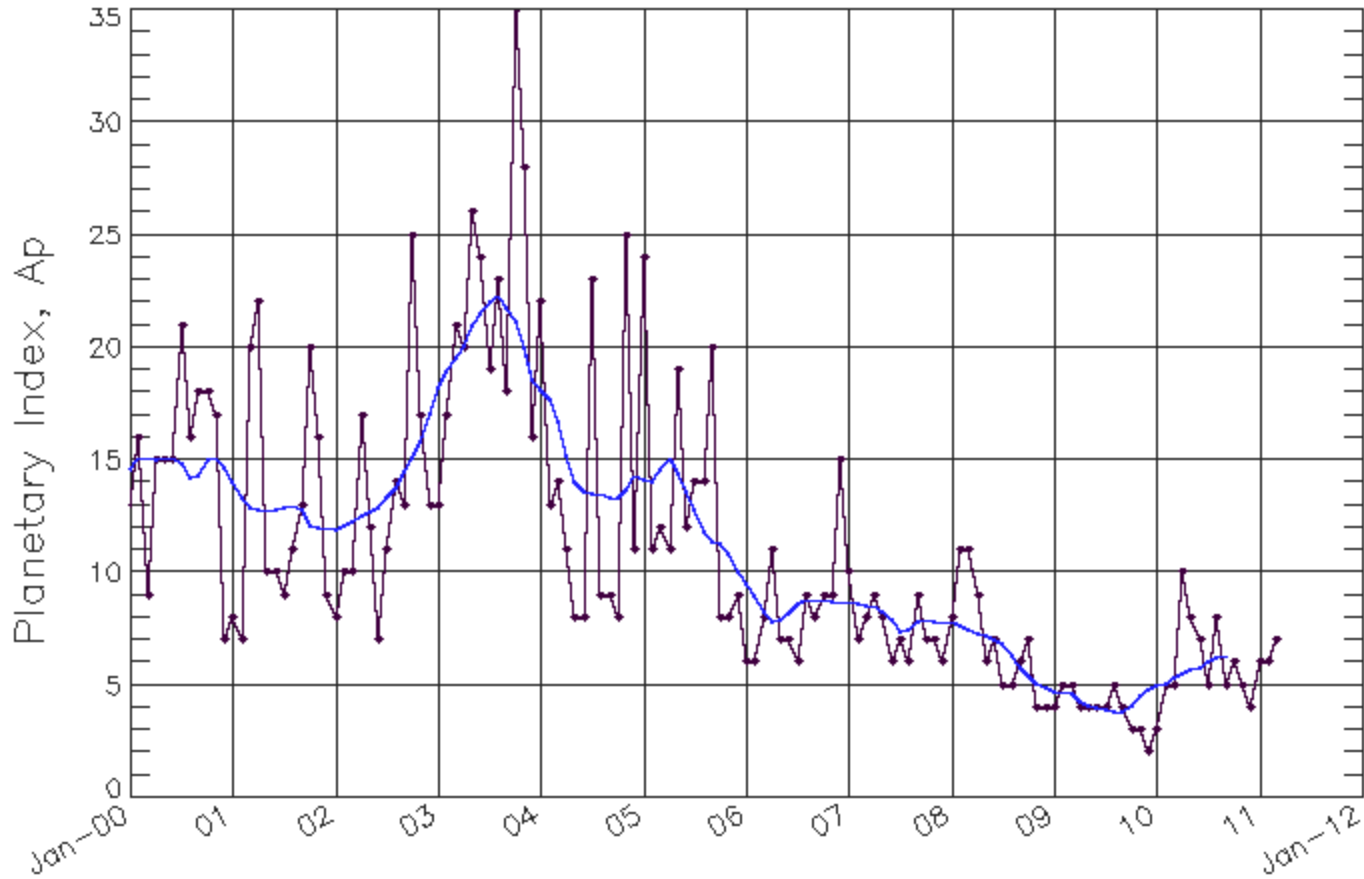

— Smoothed Monthly Values — Monthly Values

Updated 2011 Apr 5

NOAA/SWPC Boulder, CO USA